

Article number: 50300251

Description: Closed pillow block PMC 25
FM standard bearing included

Measures

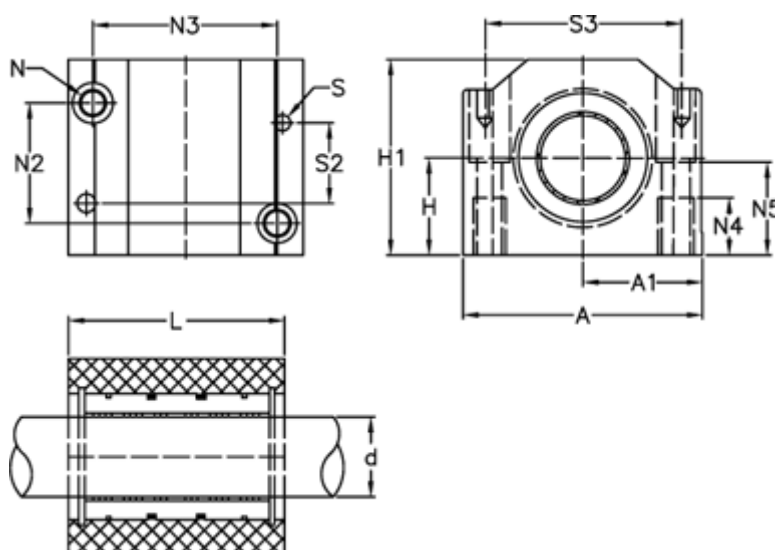

A = 78	N4 = 22
A1 = 39	N5 = 29
H = 30	S = 6
H1 = 60	S2 = 20
L = 67	S3 = 64
N = M10 x 1,5	Static load (kg) = 3046
N2 = 40.15	Weight (kg) = 0.655
N3 = 60.15	